

AIRVGA™

Wireless

Presentation System

User Manual

v.1

All names and trademarks are property of their respective companies.
All information is subject to change without notice.

(VW-1P)



I. OVERVIEW & FEATURES

airVGA™ Wireless Presentation System wirelessly enable any projector! It is plug-and-play, right out the box. Any desktop or notebook PC's with wireless connection can access the projector without swapping any cables. It also works with HDTV's VGA/PC port and built-in proprietary technology that allows smooth streaming of audio and video in MPEG formats.

airVGA™ is ideal for classrooms & conference area. It is perfect for PowerPoint & real-time video presentations. It has log-in protection that provides secured access to the projector.

Features:

- Share a projector thru wireless connection
 - Supports streaming video including MPEG 1, 2, & 4 formats
 - Supports 1024x768 or 1280x768 screen resolutions
 - Built-in DHCP server provides greater installation flexibility
 - Web-based user interface for easy configuration
 - Conference control function is perfect for training sessions
 - Session security log-in and Wi-Fi WEP protection
 - Works with Windows Vista/XP/2000 systems
-
- Supports IEEE802.3 RJ45 LAN & IEEE802.11b/g Wi-Fi
 - Wi-Fi WEP 64bit & 128bit encryption for wireless protection
 - Up to 200ft range and works with internal or external wireless card
 - Acts as a DHCP server or works with existing local area network server
 - Supports Static IP configuration and custom SSID wireless ID
 - Provides internet connection thru its built-in RJ45 port

II. INSTALLATION

1. Assemble the VW-1P by connecting its wireless antenna to the base-unit and its power adaptor to a power outlet. Connects VW-1P Wireless to the projector's VGA port.

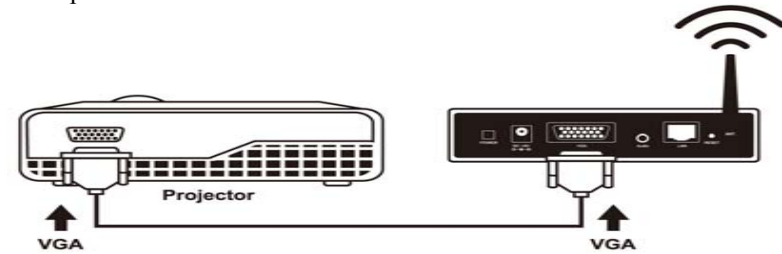

2. Make sure your computer's wireless connection is active.



3. Turn-on the projector, then turn-on VW-1P. Wait until you see the screen below on your projector.

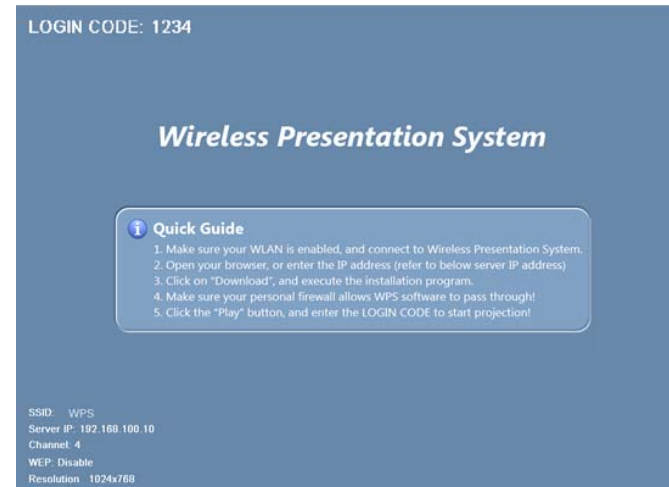

From the projector's screen, note the 4-digit Log-in Code, SSID and Server IP address. You will need this to install the player software.

4. Connect your computer to VW-1P wireless network (SSID: WPS). Most computers will automatically connect to the available wireless access point. Otherwise, click on your computer's wireless utility to select WPS to connect.
5. Open your Internet Explorer and type the Server IP shown on the screen (default is <http://192.168.100.10>) at the address bar and you'll see the screen below.

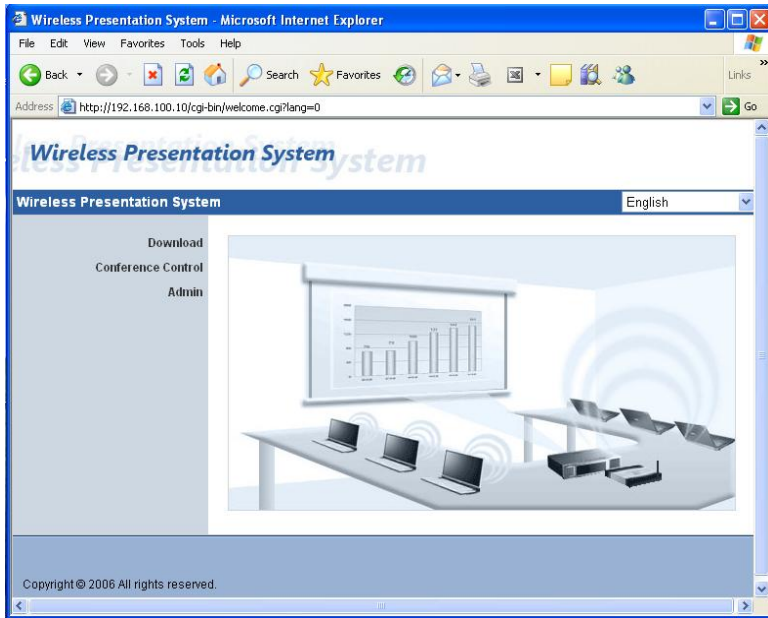

6. Click on "Download". At the prompt, enter default password "user", then click on the "Download" button located on the right side of the screen. Click on "Run" and follow the instruction to install the player software. It will create a desktop icon called "WPS".

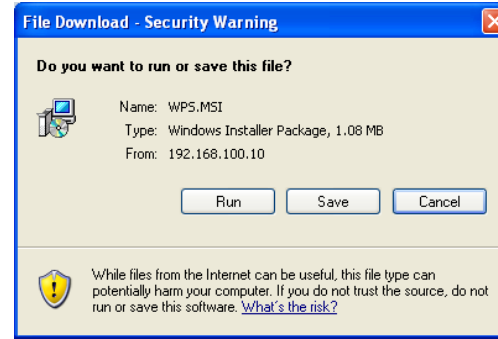

7. At your desktop, click on "WPS". The program will search the network and at the prompt, enter the 4 digit log-in code.



Note: If WPS failed to connect, make sure you have the correct log-in code or that your wireless card connection is properly configured.

After a successful log-in, click OK on next prompt including screen resolution changes. Once you exit the application, your computer screen will go back to its original screen resolution settings.

8. Click "Play" to start sending your screen to the projector.



Note: For Video Streaming, see "Playing Video Streaming" under WPS Application Software section.

III. WPS APPLICATION SOFTWARE

1. WPS application software is built-in into the module and accessible thru Internet Explorer web browser. Its default IP address is 192.168.100.10. It can be change in WPS Admin section.
2. After you log-in successfully, these are two main user interface

Standard Mode (Screen Mirroring):



Video Streaming Mode:

(when you click on "video" from the standard mode)



Here are its icons/buttons and its function.



Presentation Mode



Video Mode



Start projecting



Pause projecting



Stop projecting



Refresh projecting screen



Server Login Code



While projecting in progress, this icon is blinking



Start Playing Video



Stop Playing Video



Pause Playing video



Open Video File



Audio volume ON.



Audio volume OFF

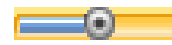

Audio volume strength bar



Video time bar



While playing video, it will be blinking



Function menu



Minimize the program



Exit the program

3. Playing Streaming Video



Click  to switch to Video Streaming Mode.



Click  to open the video file and submit to play it.

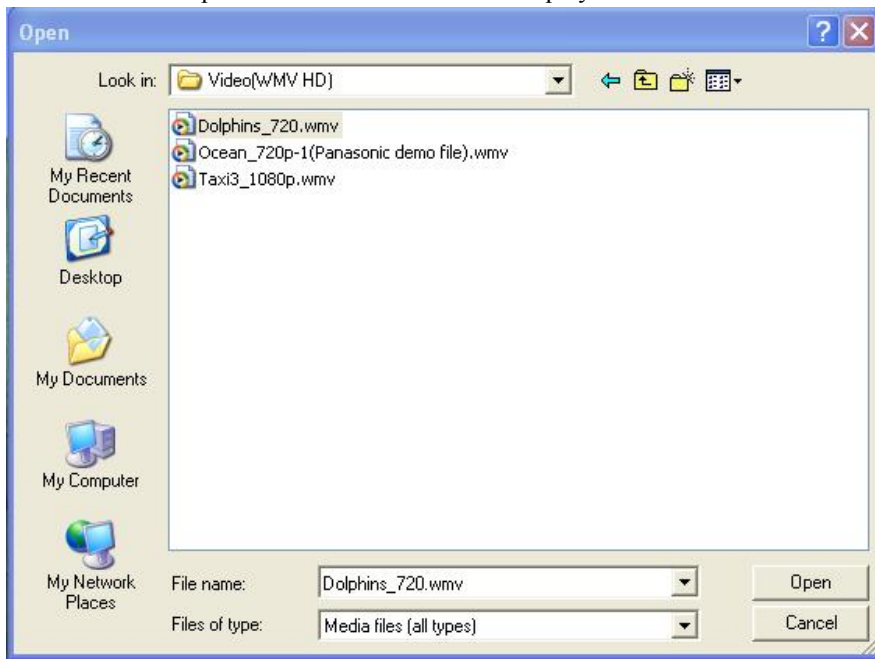

Note: Only the MPEG formats are supported including MPEG 1 (MPG, MPEG, DAT), MPEG2 (MPG, MPEG, VOB), MPEG4 (ASF, WMW9, WMW, AVI). It does not support QuickTime video files (MOV).

The audio port on the VW-1P is only for streaming video and requires IEEE802.11g.

IV. CONFERENCE CONTROL

Conference Control Administrator screen allows the host or presenter to maintain order in presentations especially when there are many users who are currently log-in at the same time.

1. Open your Internet Explorer and type the Server IP shown on the screen (default is <http://192.168.100.10>) at the address bar and you'll see the screen below.

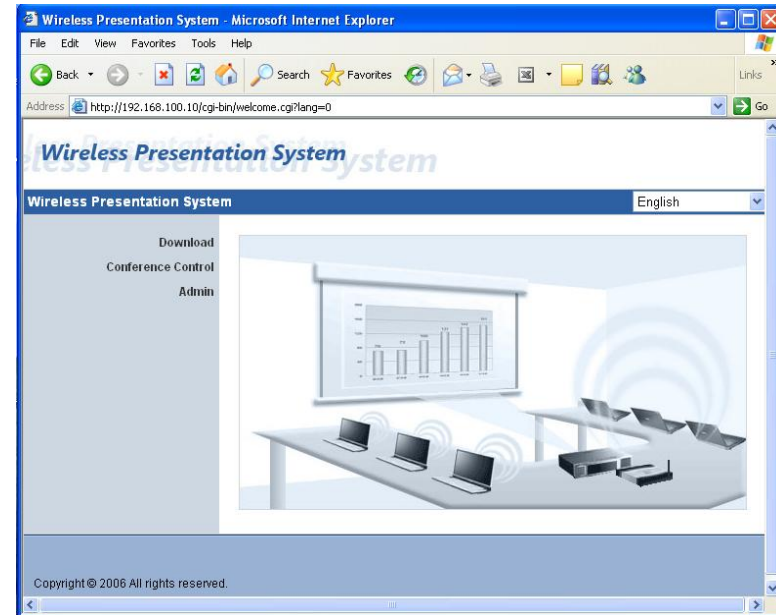

2. Click “**Conference Control**”, enter the default password “trainer”, click log-in. On this screen, you will see all users who currently log-in.



3. “**Play Control**” shows the status of currently log-in users. These are toggle icon that allows the host to play or stop the presentation.



V. WEB ADMIN

Web Admin allows you to customized WPS default settings and monitor system status including setup changes for network, projection, passwords & firmware upgrade. You can also reset the VW-1P to its default settings or re-start it remotely.

WARNING: CAREFUL WHEN MAKING ANY CHANGES.
ANY MODIFICATION TO DEFAULT SETTINGS MAY REQUIRE CORRESPONDING CHANGES TO COMPUTERS CONNECTED TO VW-1P.

1. Open your Internet Explorer and type the VW-1P Server IP address (default is <http://192.168.100.10>) at the address bar. Click “Admin” and enter the password (default password is admin).



2. Here is the information that can be found under “System Status”:

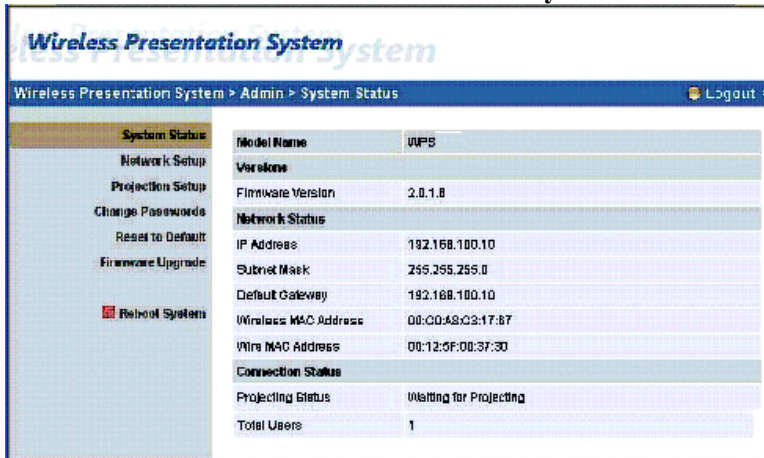

3. Network configuration including changes to IP addressing, DHCP Server, Wireless and GateKeeper are under “Network Setup”.

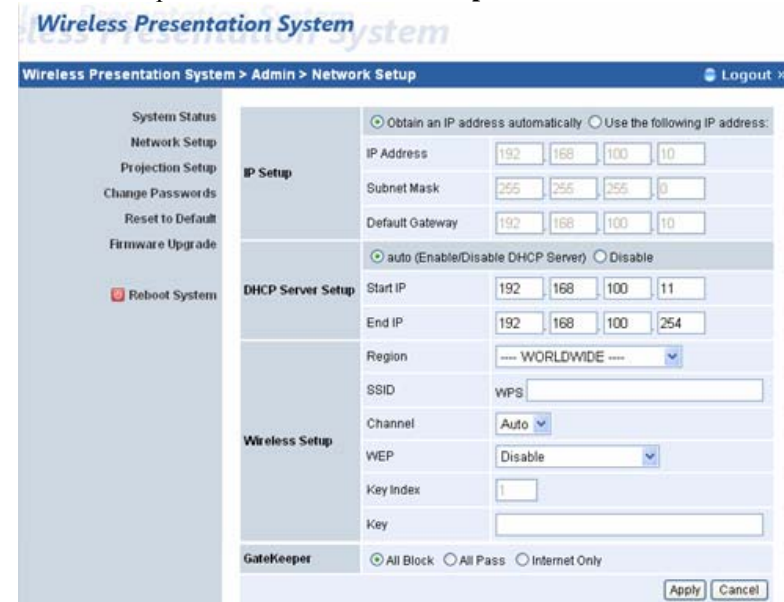

GateKeeper: Another layer of network security. All Block will not allow office network access, All Pass allows office network access while Internet Only don't allow office network access but still have internet. This feature is only active when VW-1P is connected to a local area network, internet or both.

Please consult your network administrator for changes needed for IP Setup, DHCP Server and Wireless Setup when integrating VW-1P to an existing local network.

4. “Projection Setup”

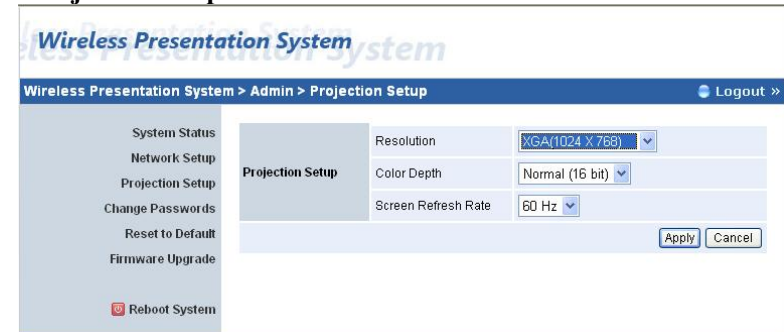

Under Projection Setup, resolution can be change between 1024x768 and 1280x768, Color Depth between 16bit and 32bit, Screen Refresh Rate between 60Hz and 75Hz to suit different type of projectors.

5. “Changing Passwords”

The screenshot shows the 'Change Passwords' page in the Wireless Presentation System Admin interface. The breadcrumb trail is 'Wireless Presentation System > Admin > Change Passwords'. A sidebar on the left lists navigation options: System Status, Network Setup, Projection Setup, Change Passwords (highlighted), Reset to Default, Firmware Upgrade, and Reboot System. The main content area is divided into three sections: 'Download', 'Conference Control', and 'Admin'. Each section contains two password input fields (Enter New Password and Confirm New Password) and an 'Apply' button.

When setting customized passwords, remember to keep a copy. If you forgot or loss the password, the only option is to reset to factory default.

After entering the password, click on “Apply”.

6. “Reset to Factory Default”

The screenshot shows the 'Reset to Default' page in the Wireless Presentation System Admin interface. The breadcrumb trail is 'Wireless Presentation System > Admin > Reset to Default'. A sidebar on the left lists navigation options: System Status, Network Setup, Projection Setup, Change Passwords, Reset to Default (highlighted), Firmware Upgrade, and Reboot System. The main content area features a warning icon and the text: 'Reset to Default. This will restore the device to the factory default settings.' An 'Apply' button is located at the bottom of the main content area.

This will restore the VW-1P to factory defaults.

You can also reset VW-1P thru the following these procedures:
Power-off the VW-1P, on the rear panel press RESET button and hold it for 10 seconds while turning-on the VW-1P.

7. “Firmware Upgrade”

Do this only when instructed by the factory technician since it can render your VW-1P un-usable.

8. “Reboot”

The screenshot shows the 'Reboot System' page in the Wireless Presentation System Admin interface. The breadcrumb trail is 'Wireless Presentation System > Admin > Reboot System'. A sidebar on the left lists navigation options: System Status, Network Setup, Projection Setup, Change Passwords, Reset to Default, Firmware Upgrade, and Reboot System (highlighted). The main content area features a warning icon and the text: 'Reboot System. This will reboot the device immediately.' A 'Reboot' button is located at the bottom of the main content area.

It allow you to do soft-re-start or your network administrator the capability to remotely re-start VW-1P.

VI. NETWORK APPLICATION DIAGRAMS

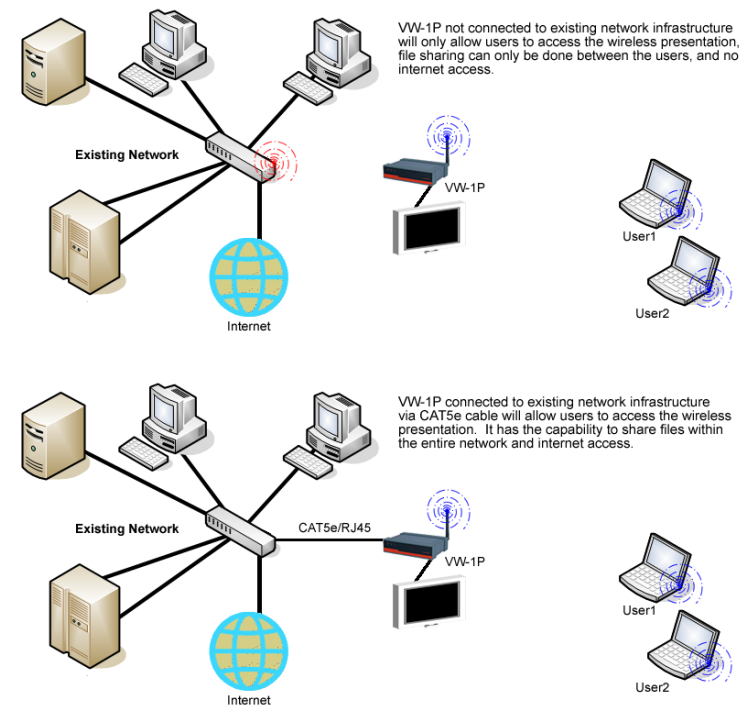

WALL MOUNT INSTRUCTION (OPTIONAL):

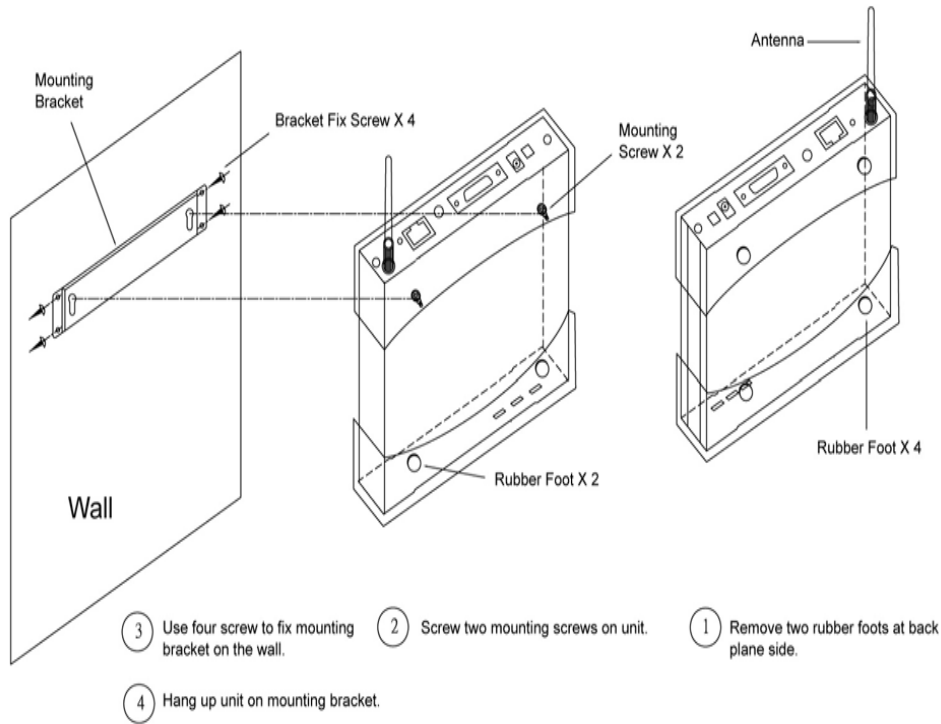

TECHNICAL SPECIFICATIONS:

- Screen Resolutions 1024x768 (XGA) / 1280x768 (WXGA)
- Video Streaming Up to 30fps with Audio
- Video Formats MPEG1, MPEG2, MPEG4, WMV, AVI
- Network Connections Wi-Fi IEEE802.11b, IEEE802.11g
Fast Ethernet IEEE802.3 10/100Mbps
- Wireless Speed 11Mbps, 54Mbps
- Wireless Frequency 2.4GHz
- Wireless Channels 11
- Wireless Encryption WEP 64 or 128bit
- Wireless Antenna Detachable SMA (-3dBi)
- Wireless Range Up to 200ft*
- LAN Protocol TCP/IP
- LAN Type AP Mode, Hybrid (AP + LAN)
- IP Configuration Automatic or Manual (Static)
- OS Compatibility Windows 2000, XP & Vista
- Connectors RJ45 LAN, HD15 VGA, 3.5mm Audio, SMA
- Power Supply AC Power Adaptor (included)
- Certification FCC, CE
- Warranty One Year
- UPC 0 37229 00732 9
- SKU VW-1P